

(312) 557-1515

[www.clintonlaw.net](http://www.clintonlaw.net)

[www.chicagolegalmalpracticelawyerblog.com](http://www.chicagolegalmalpracticelawyerblog.com)

This email may contain information that is PRIVILEGED and CONFIDENTIAL under the ATTORNEY-CLIENT PRIVILEGE. If you receive it in error, please delete it and notify the undersigned.

If you are a client of this firm, please keep this email confidential.

Finally, this email, by itself, does not create or establish an attorney-client relationship.

<Correspondence Part I.pdf><Correspondence Part II.pdf><Mast.Letter.071513.pdf>

<Mast.Letter.073012.pdf><Misc Telephone Conf Notes.pdf>

**These 4 nubs of ruled lines clearly shows this is one paper laid over the top of another.  
This is best seen on POP 001317, Dulberg 008122, Dulberg 4366, Dulberg 1882**

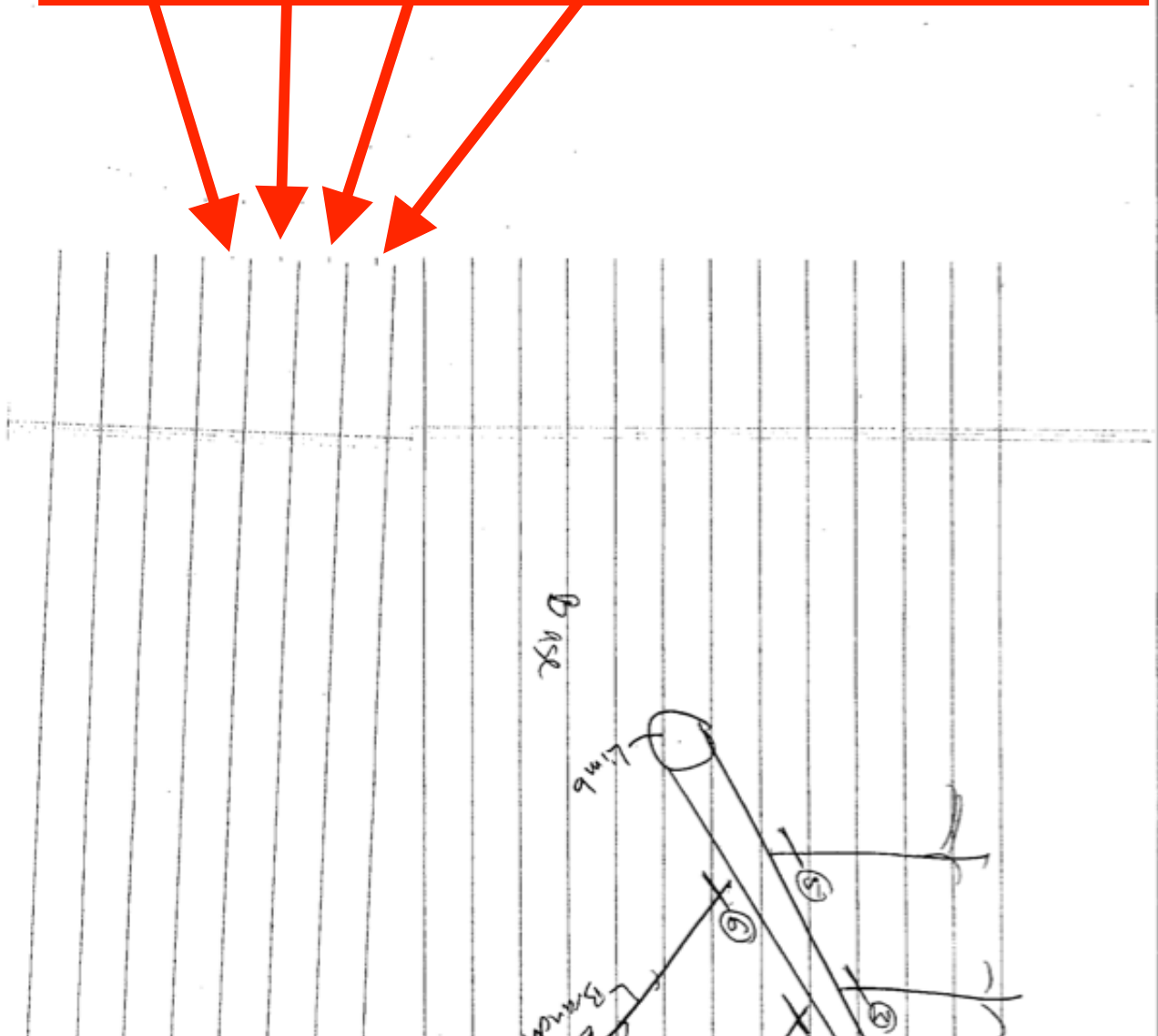



2



Photos of Injury.pdf

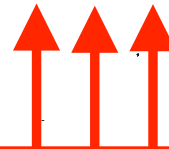
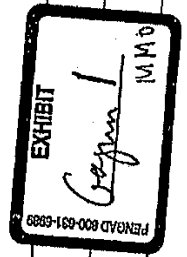
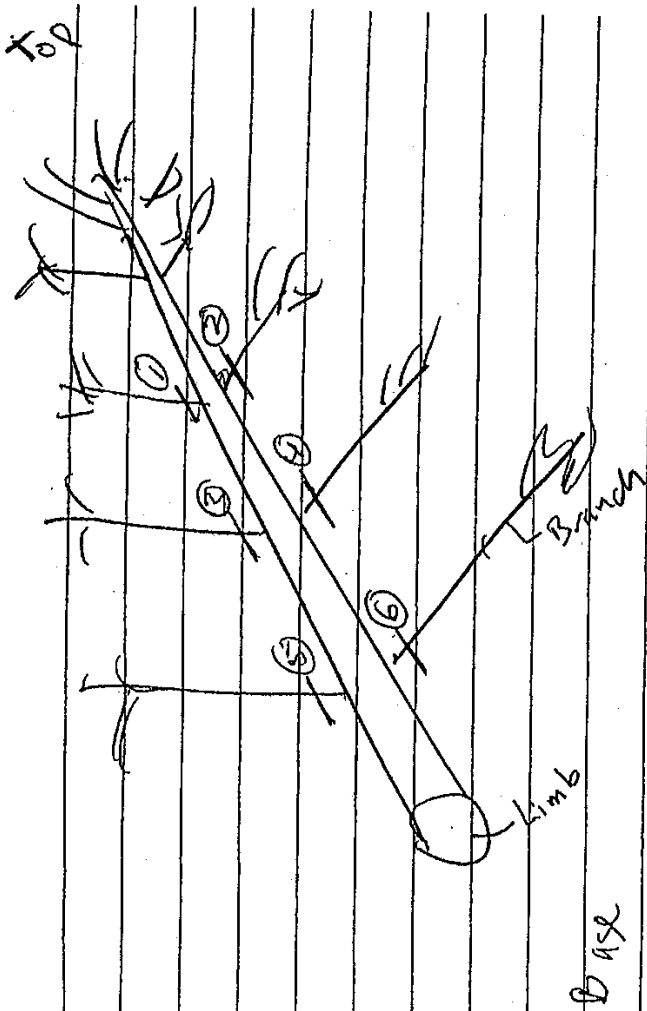

Poor quality copies lose the 4th nub  
from the ruled lines  
This is seen on Dulberg 008118, Dulberg 003762, Dulberg 000759



LAW OFFICE OF  
**SCOTT A. HIERA, LLC**

The Logo & Type is overlaid on top of the image

Scott A. Hiera  
Bryan D. Sullivan

Jenny Hay Office Manager/Paralegal  
Debra L. Sabo - Paralegal

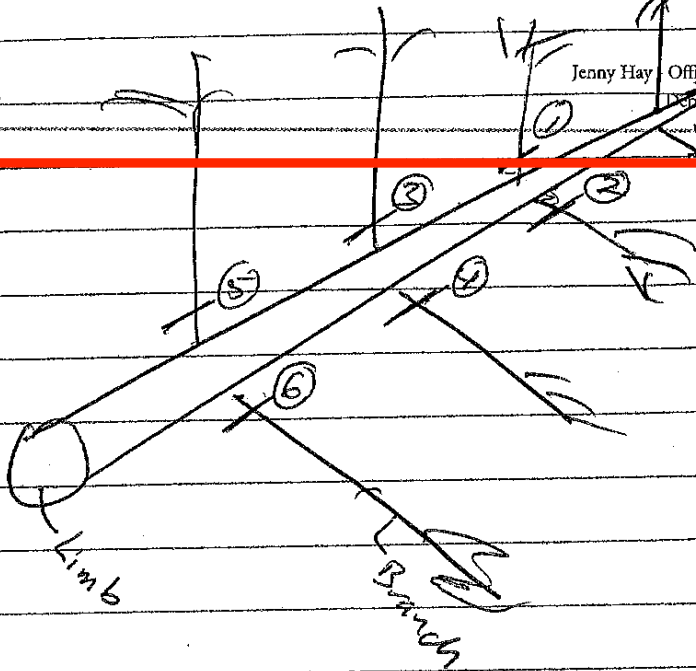

TOP

The nubs from the ruled lines have been trimmed or cropped



The Type is overlaid on top of the image

3421 W. Elm Street McHenry, IL 60050 Ph: 815.344.6300 Fax: 815.344.6907  
www.got-injured.com www.bad-marriage.com

Dulberg 001257



The Logo & Type is overlaid on top of the image

LAW OFFICE OF  
**SCOTT A. HIERA, LLC**

Scott A. Hieria  
Bryan D. Sullivan

Jenny Hay - Office Manager/Paralegal  
Debra L. Sabo - Paralegal

TOP

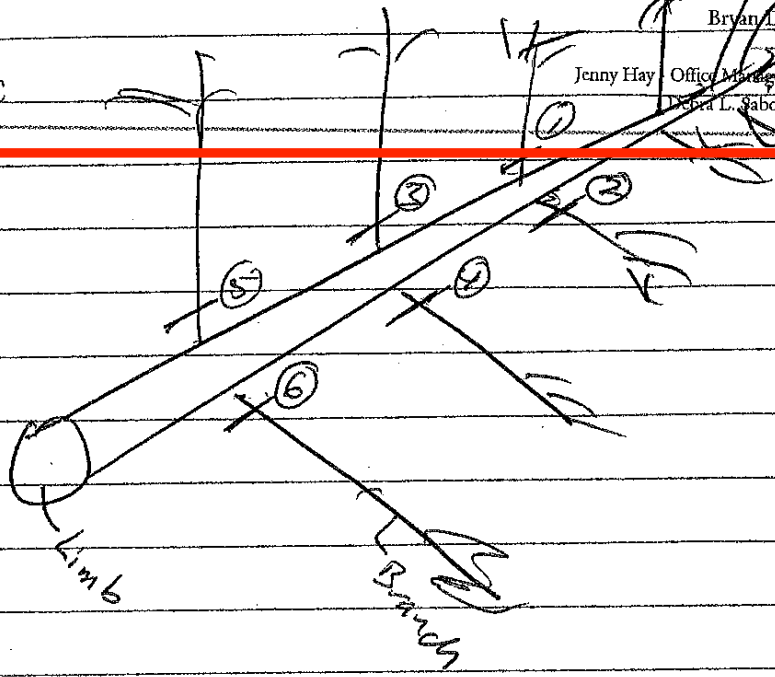

The nubs from the ruled lines have been trimmed or cropped

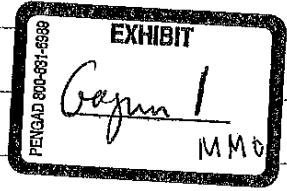

The Type is overlaid on top of the image

3421 W. Elm Street McHenry, IL 60050 Ph: 815.344.6300 Fax: 815.344.6907  
www.got-injured.com www.bad-marriage.com

Dulberg 001258

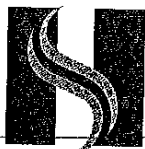

LAW OFFICE OF  
**SCOTT A. HIERIA, LLC**

The Logo & Type is overlaid on top of the image

Scott A. Hieria  
Bryan D. Sullivan  
Jenny Hay Office Manager/Paralegal  
Debra L. Sabo - Paralegal

top

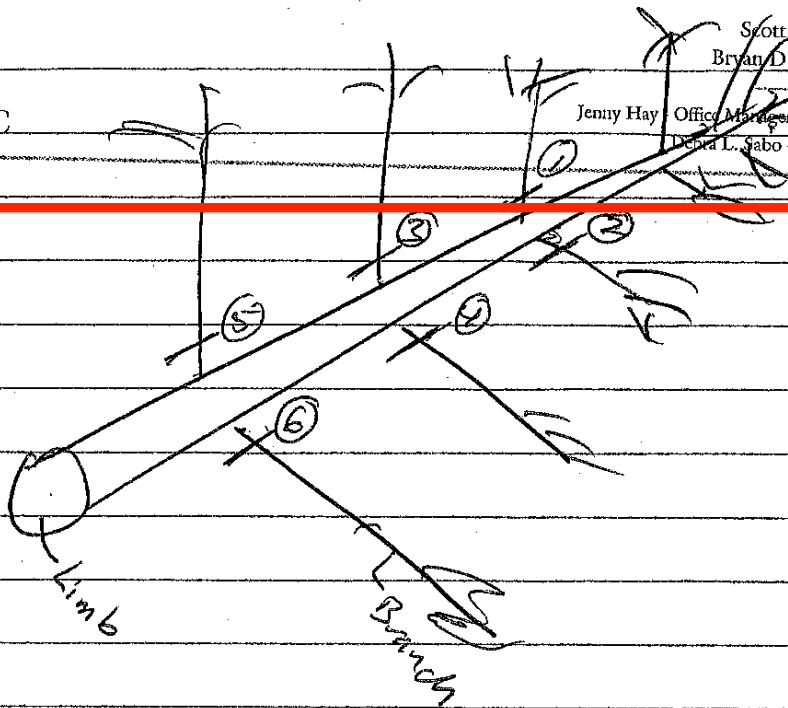

The nubs from the ruled lines have been trimmed or cropped



The Type is overlaid on top of the image

3421 W. Elm Street McHenry, IL 60050 Ph: 815.344.6300 Fax: 815.344.6907  
www.got-injured.com www.bad-marriage.com

Dulberg 001259

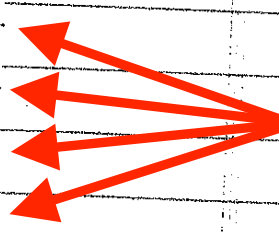
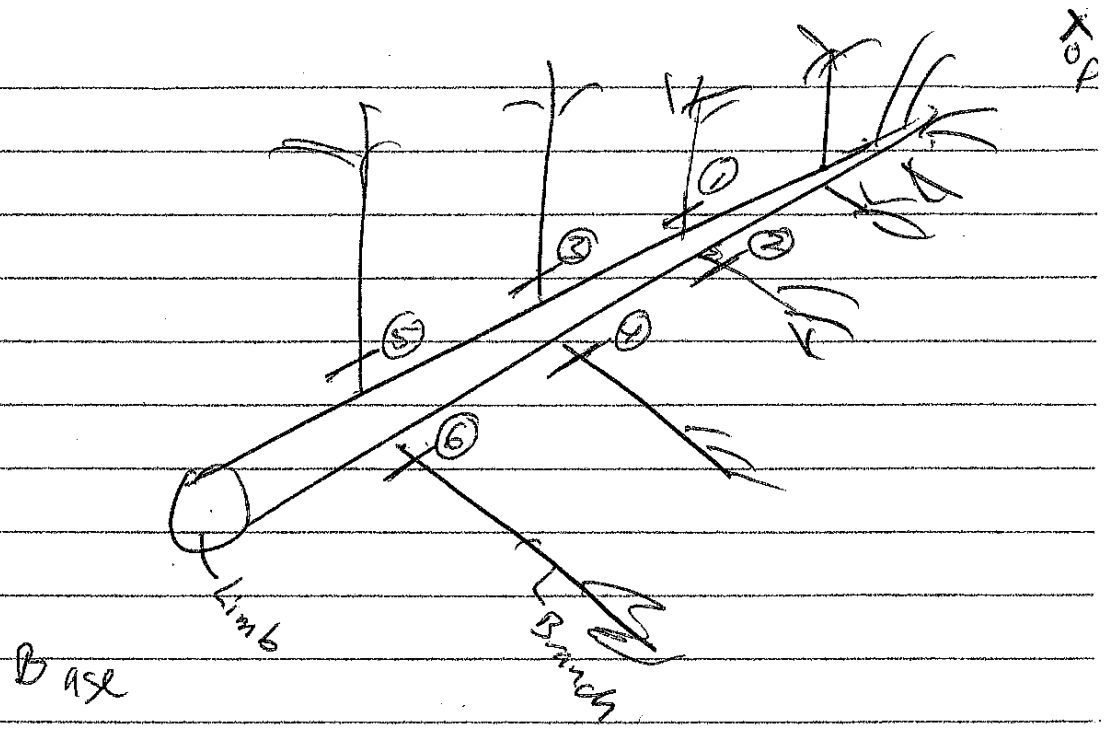

These 4 nubs of ruled lines clearly shows this is one paper laid over the top of another.



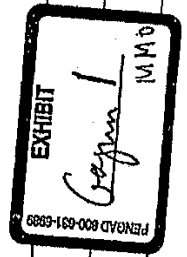
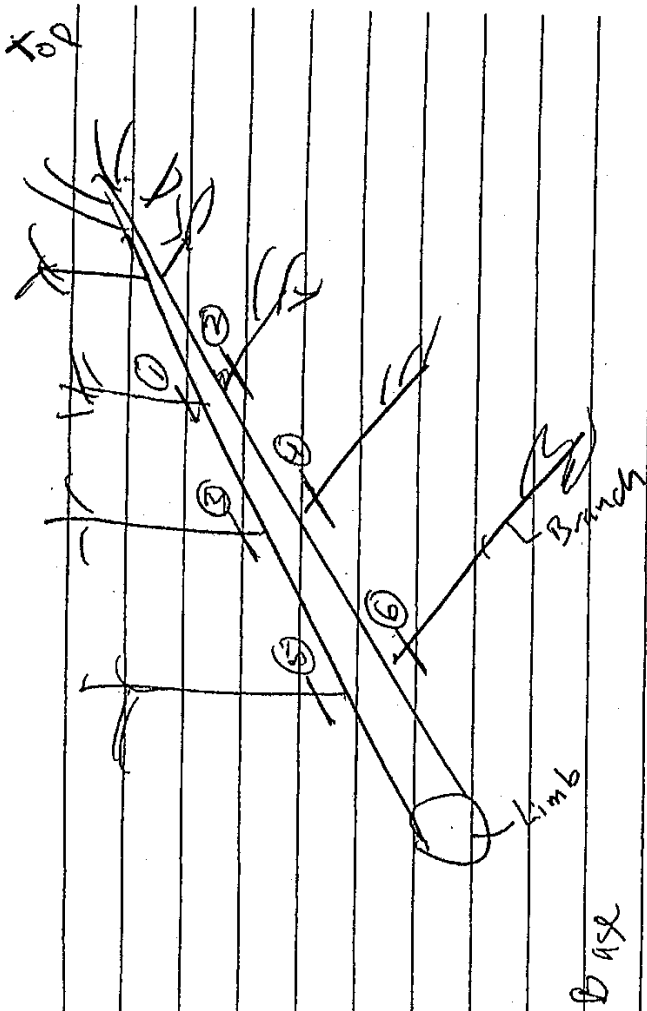

↑ ↑ ↑  
**Poor quality copies loose the 4th nub  
from the ruled lines**



LAW OFFICE OF  
**SCOTT A. HIERA, LLC**

The Logo & Type is overlaid on top of the image

Scott A. Hiera  
Bryan D. Sullivan

Jenny Hay - Office Manager/Paralegal  
Debra L. Sabo - Paralegal

TOP

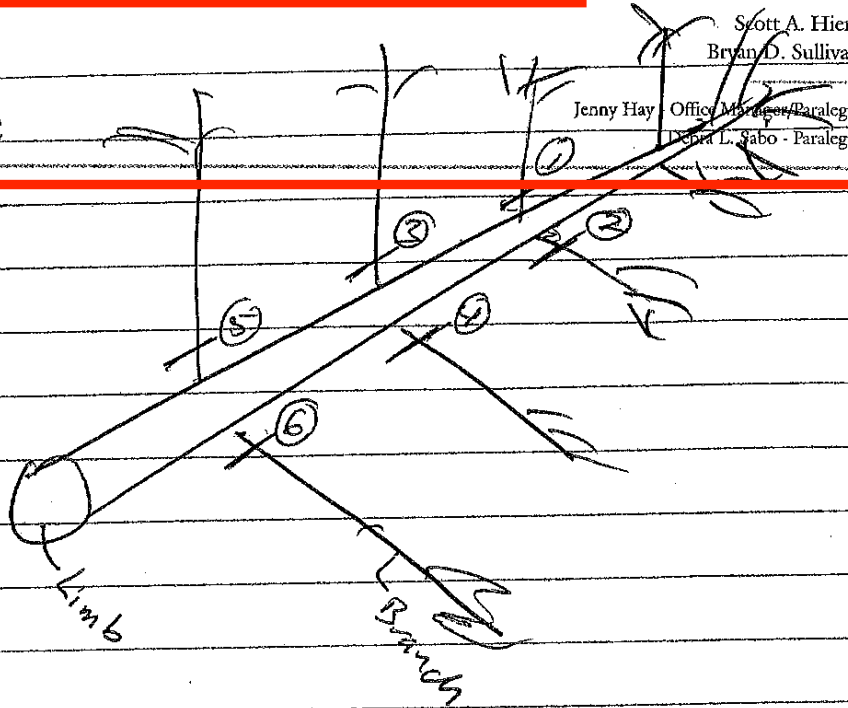

The nubs from the ruled lines have been trimmed or cropped

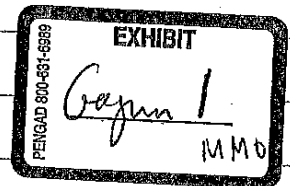

The Logo & Type is overlaid on top of the image

3421 W. Elm Street McHenry, IL 60050 Ph: 815.344.6300 Fax: 815.344.6907  
www.got-injured.com www.bad-marriage.com

Dulberg 004119



LAW OFFICE OF  
**SCOTT A. HIER, LLC**

The Logo & Type is overlaid on top of the image

Scott A. Hier  
Bryan D. Sullivan

Jenny Hay - Office Manager/Paralegal  
Debra L. Sabo - Paralegal

X  
OP

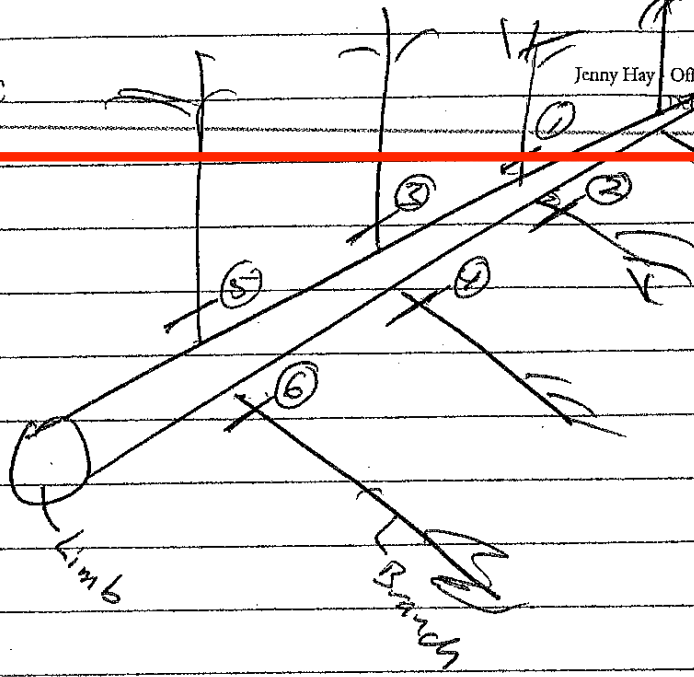

The nubs from the ruled lines have been trimmed or cropped



The Type is overlaid on top of the image

3421 W. Elm Street McHenry, IL 60050 Ph: 815.344.6300 Fax: 815.344.6907  
www.got-injured.com www.bad-marriage.com

Dulberg 004120



LAW OFFICE OF  
**SCOTT A. HIERIA, LLC**

The Logo & Type is overlaid on top of the image

Scott A. Hieria  
Bryan D. Sullivan

Jenny Hay Office Manager/Paralegal  
Debra L. Sabo - Paralegal

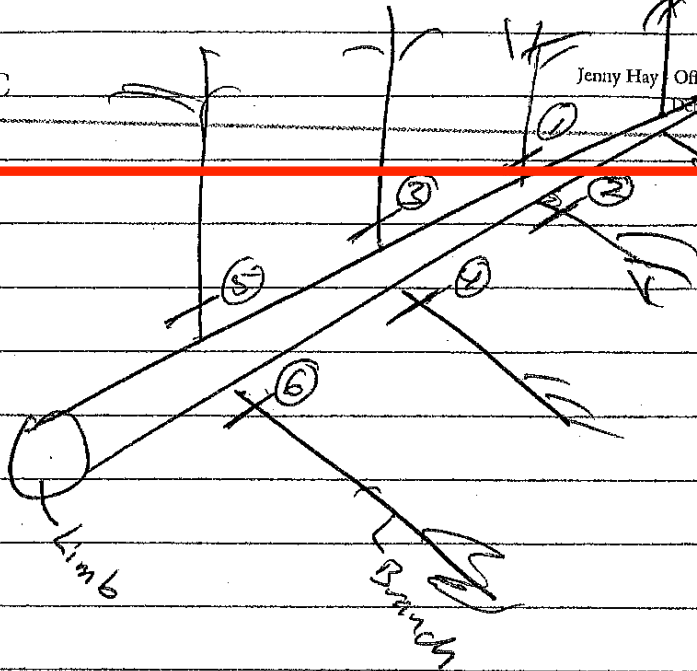

The nubs from the ruled lines have been trimmed or cropped



The Type is overlaid on top of the image

3421 W. Elm Street McHenry, IL 60050 Ph: 815.344.6300 Fax: 815.344.6907  
www.got-injured.com www.bad-marriage.com

Dulberg 004121

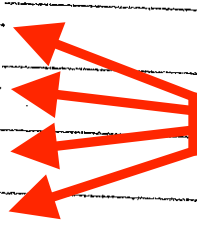
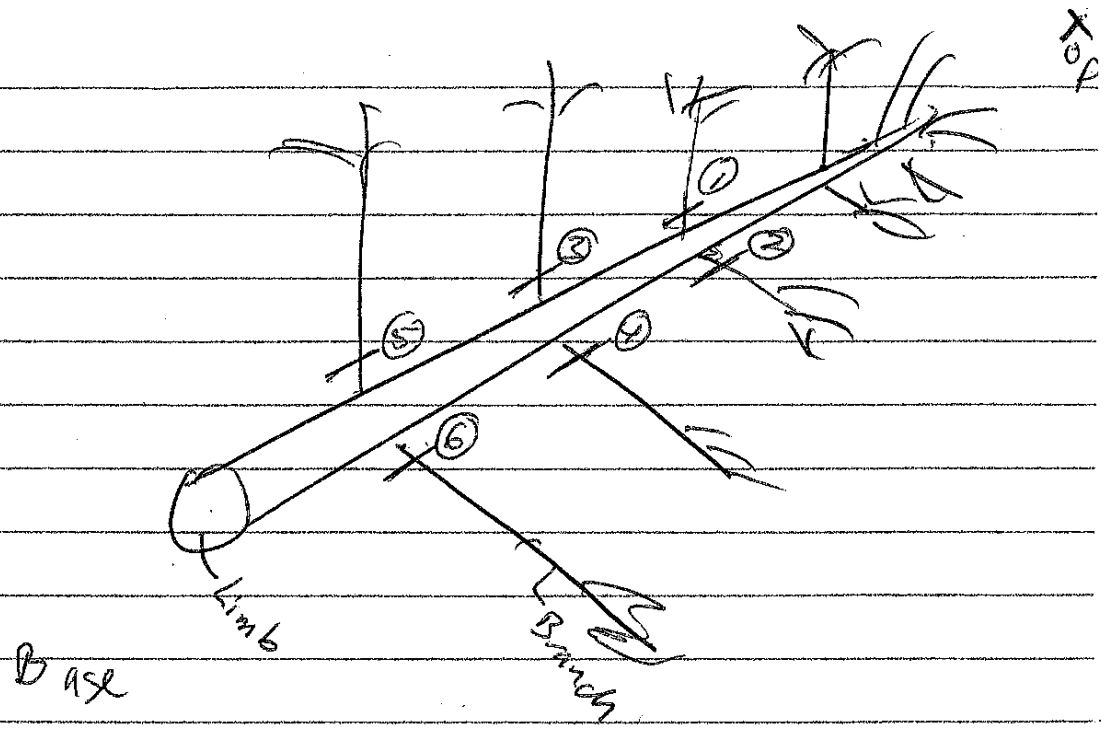

These 4 nubs of ruled lines clearly shows this is one paper laid over the top of another.



Top

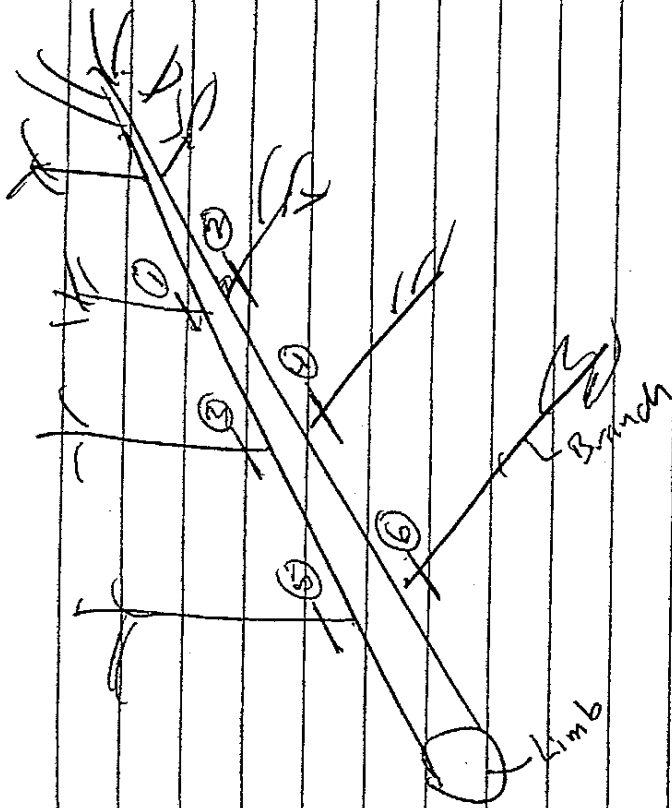

Base

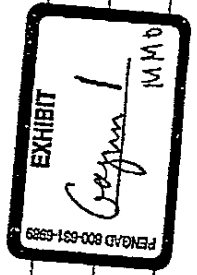

↑ ↑ ↑  
Poor quality copies lose the 4th nub  
from the ruled lines

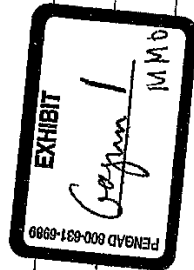
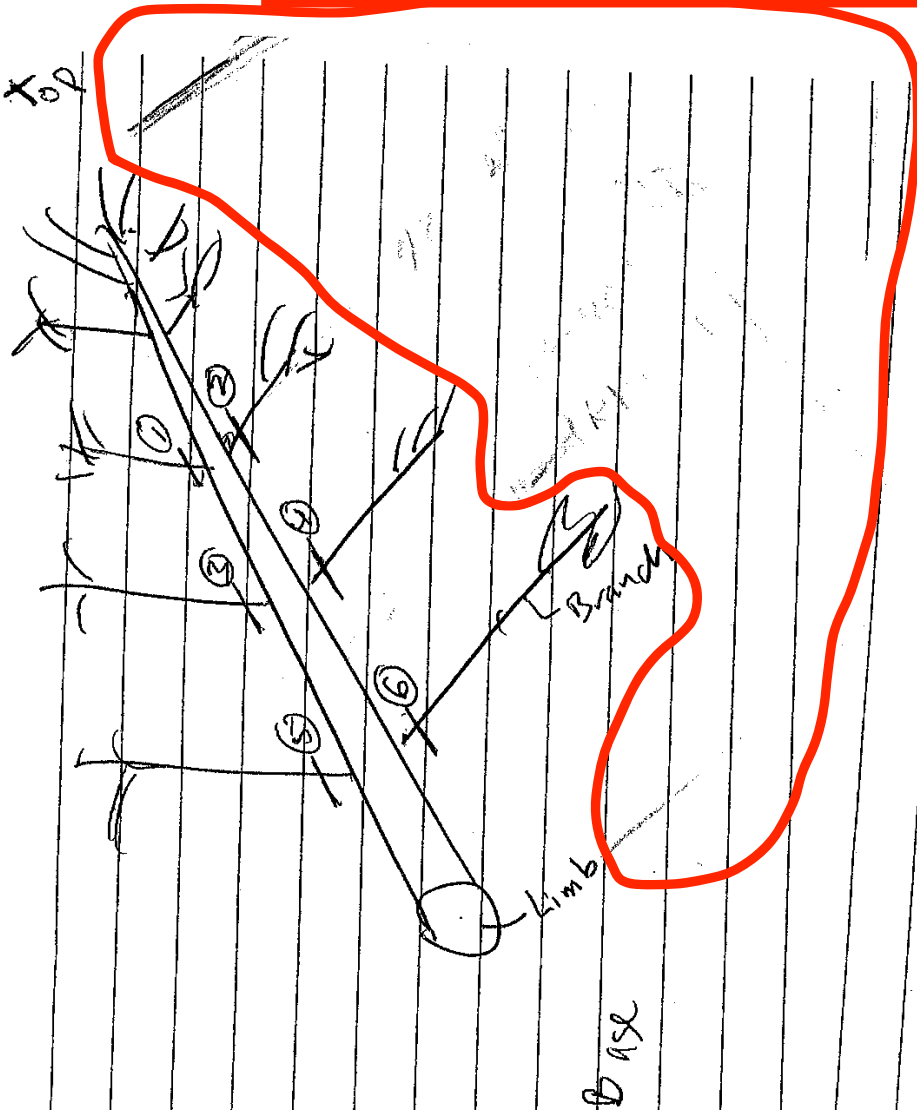

MAST  
 Dulberg  
 Cajon

Sticky Note covers the nubs from the ruled lines

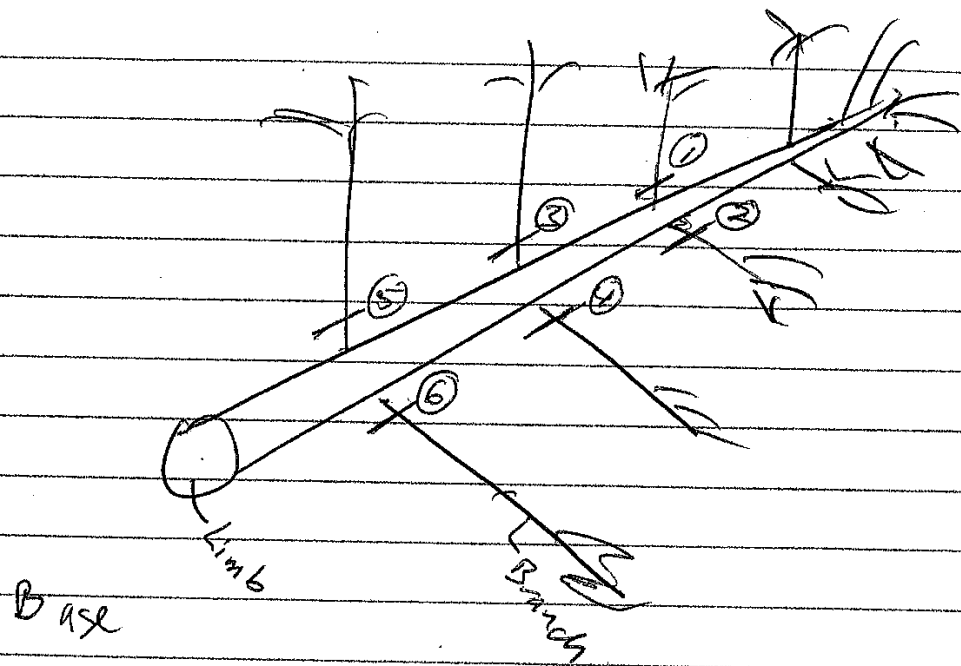

These 4 nubs of ruled lines clearly shows this is one paper laid over the top of another.

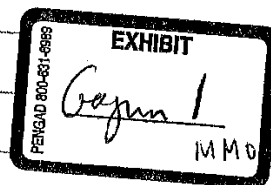



LAW OFFICE OF  
**SCOTT A. HIERA, LLC**

The Logo & Type is overlaid on top of the image

Scott A. Hieras  
Bryan D. Sullivan  
Jenny Hay Office Manager/Paralegal  
Debra L. Sabo - Paralegal

X  
of

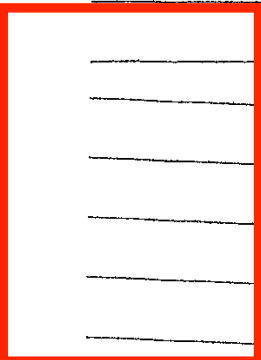
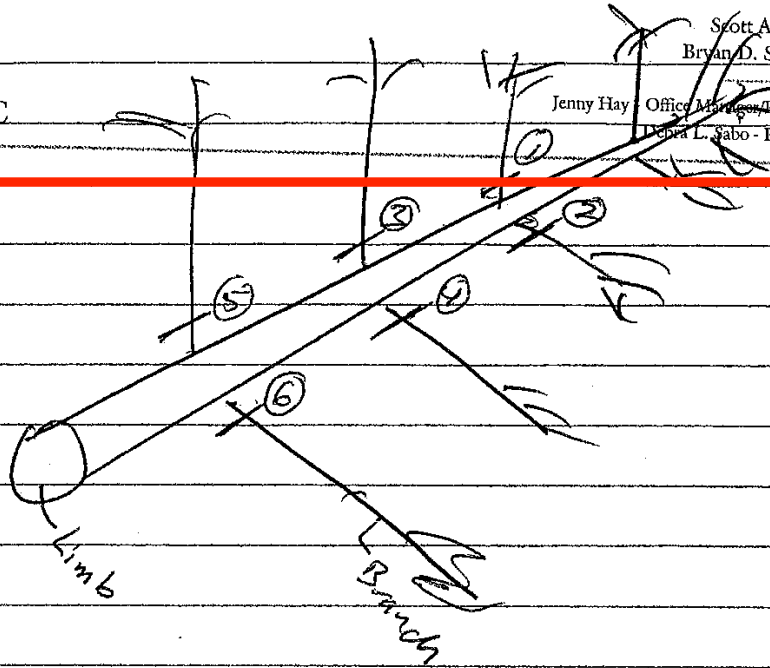

The nubs from the ruled lines have been trimmed or cropped

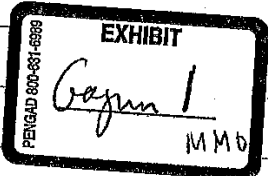

The Type is overlaid on top of the image

3421 W. Elm Street McHenry, IL 60050 Ph: 815.344.6300 Fax: 815.344.6907  
www.got-injured.com www.bad-marriage.com

The Logo & Type is overlaid on top of the image



LAW OFFICE OF  
**SCOTT A. HIERA, LLC**

Scott A. Hieria  
Bryan D. Sullivan

Jenny Hay Office Manager/Paralegal  
Debra L. Sabo - Paralegal

X  
0  
4

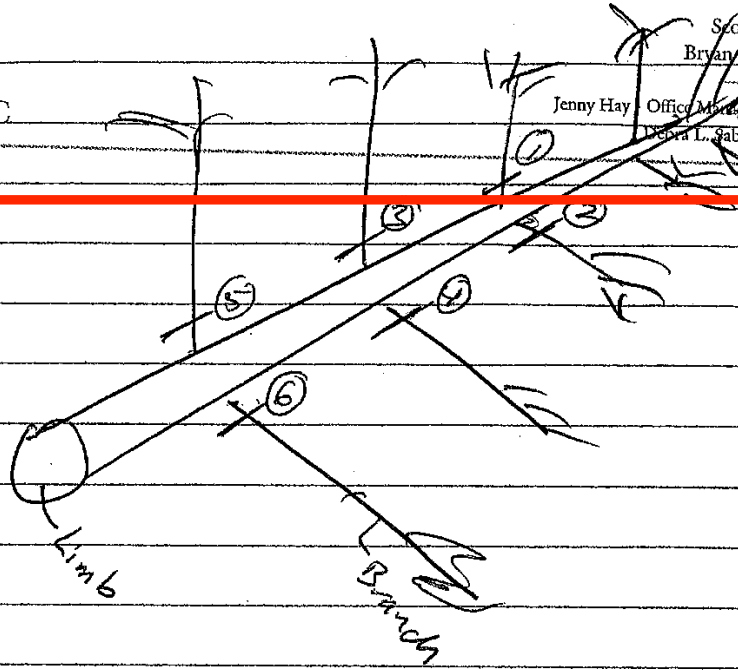

The nubs from the ruled lines have been trimmed or cropped



The Type is overlaid on top of the image

3421 W. Elm Street McHenry, IL 60050 Ph: 815.344.6300 Fax: 815.344.6907  
www.got-injured.com www.bad-marriage.com



LAW OFFICE OF  
**SCOTT A. HIERIA, LLC**

The Logo & Type is overlaid on top of the image

Scott A. Hieria  
Bryan D. Sullivan

Jenny Hay Office Manager/Paralegal  
Debra L. Sabo - Paralegal

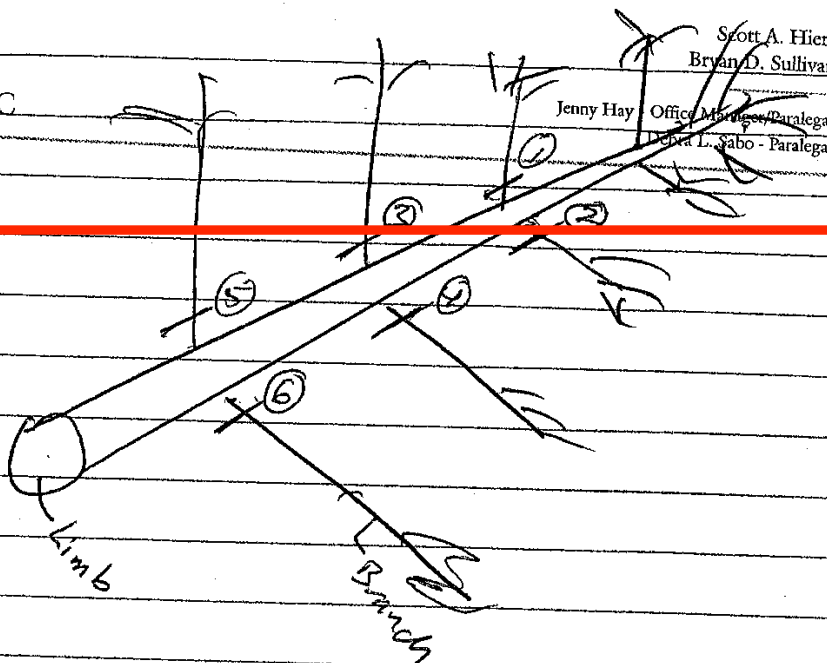

The nubs from the ruled lines have been trimmed or cropped



The Type is overlaid on top of the image

3421 W. Elm Street McHenry, IL 60050 Ph: 815.344.6300 Fax: 815.344.6907  
www.got-injured.com www.bad-marriage.com

This one is special because the nubs of the ruled lines are removed before the Logo and type are overlaid.  
Here the nubs have been removed by trimming or cropping the horizontal ruled lines on the left  
The right side appears trimmed as well.

I placed red vertical lines to show how straight the trimming/cropping turned out as well as how the printed left margin changes from the top 13-14 horizontal ruled lines on the image to the bottom 8-9 horizontal ruled lines on the image.

I placed Red Horizontal Lines to show how crooked the bottom 8-9 horizontal ruled lines look compared to the top 13-14 horizontal ruled lines.

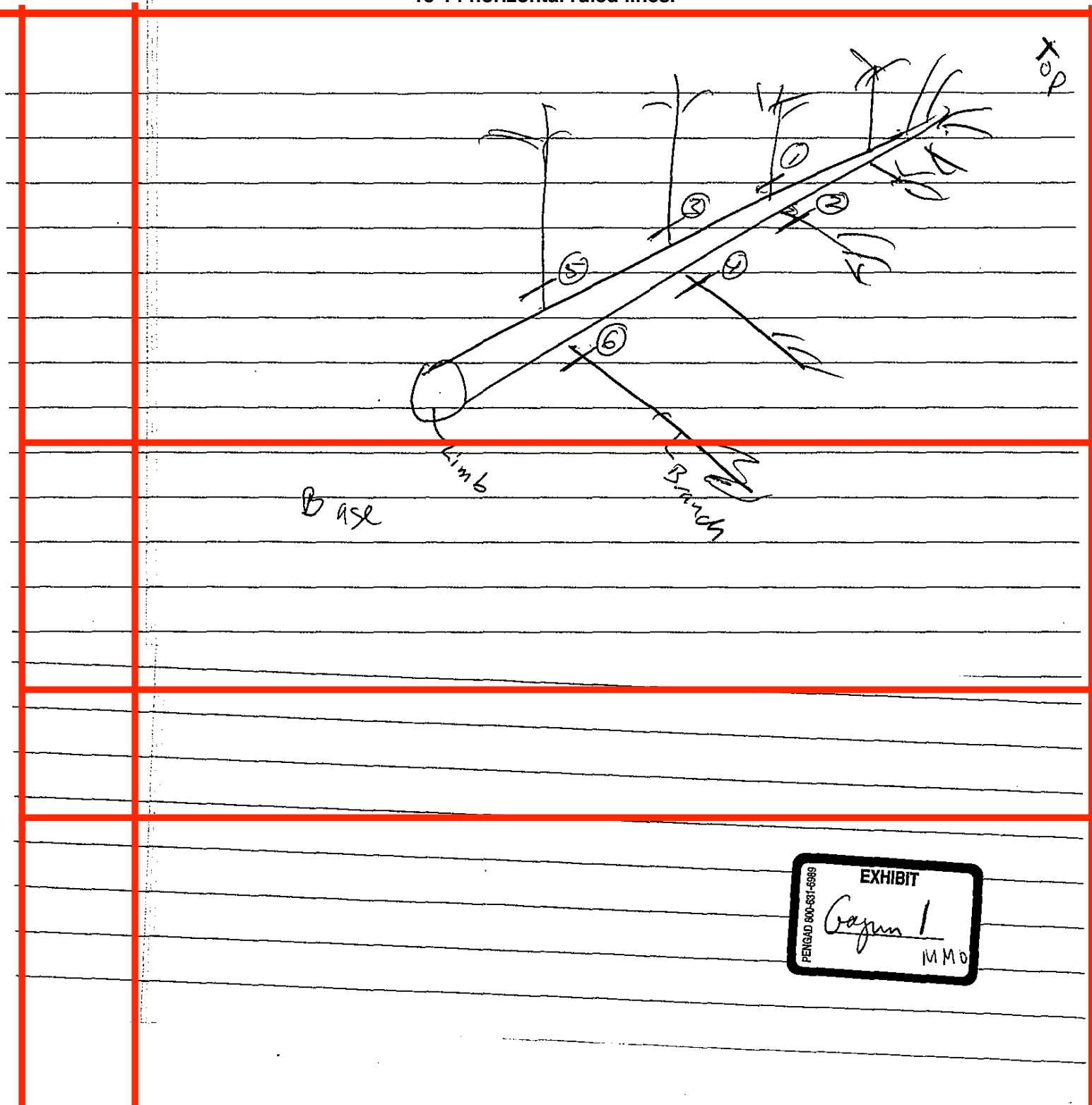

Even with the nubs of the ruled lines removed and the sides trimmed straighter,  
this is still obviously one paper laid over the top of another.  
WHY?

The Logo & Text were overlaid on the image after initial Paper over Paper and Trimming of edges of ruled lines that removed the nubs.



LAW OFFICE OF  
**SCOTT A. HIER, LLC**

Scott A. Hier  
Bryan D. Sullivan

Jenny Hay - Office Manager/Paralegal  
Debra L. Sabo - Paralegal

TOP

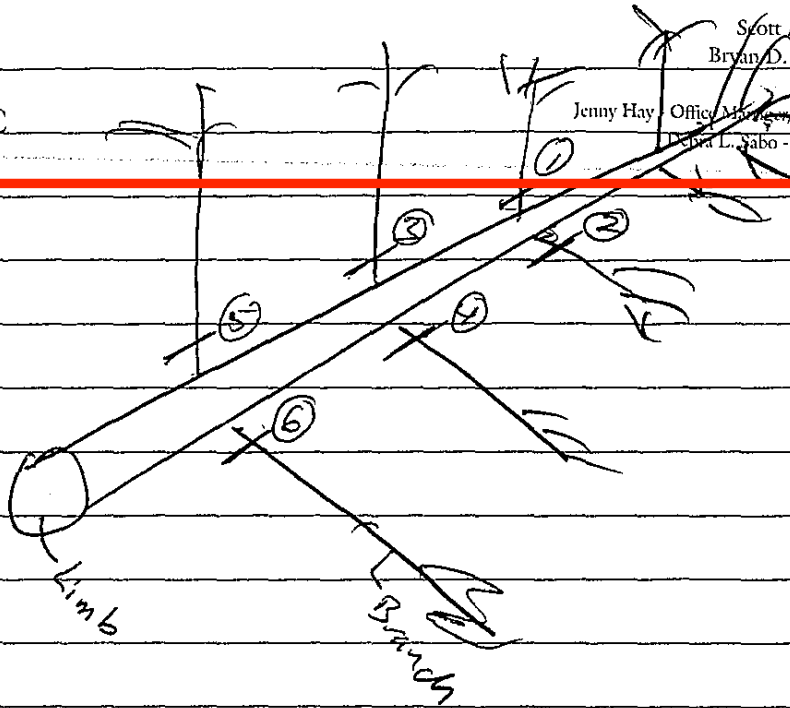



LAW OFFICE OF  
**SCOTT A. HIER, LLC**

Scott A. Hier  
Bryan D. Sullivan

Jenny Hay Office Manager/Paralegal  
Debra L. Sabo - Paralegal

TOP

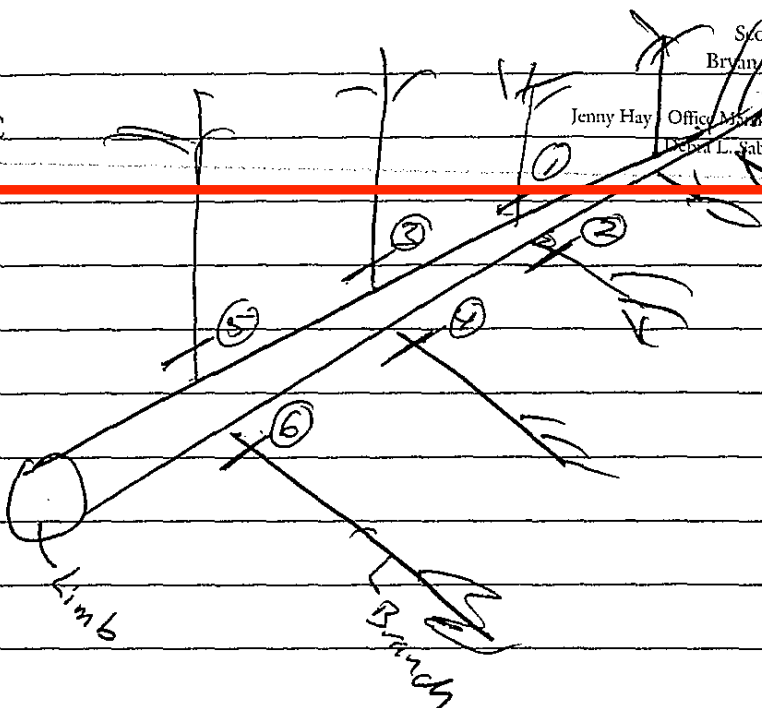

The Logo & Text were overlaid on the image after initial Paper over Paper and Trimming of edges of ruled lines that removed the nubs.



LAW OFFICE OF  
**SCOTT A. HIER, LLC**

Scott A. Hier  
Bryan D. Sullivan

Jenny Hay Office Manager/Paralegal  
Debra L. Sabo - Paralegal

top

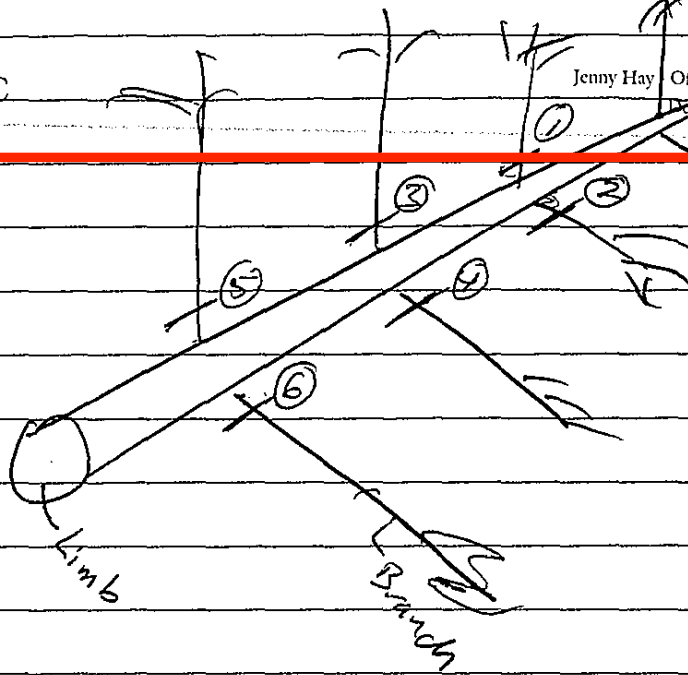

The Logo & Text were overlaid on the image after initial Paper over Paper and Trimming of edges of ruled lines that removed the nubs.

3421 W. Elm Street McHenry, IL 60050 Ph: 815.344.6300 Fax: 815.344.6907  
www.got-injured.com POP 000410 d-marriage.com

Top

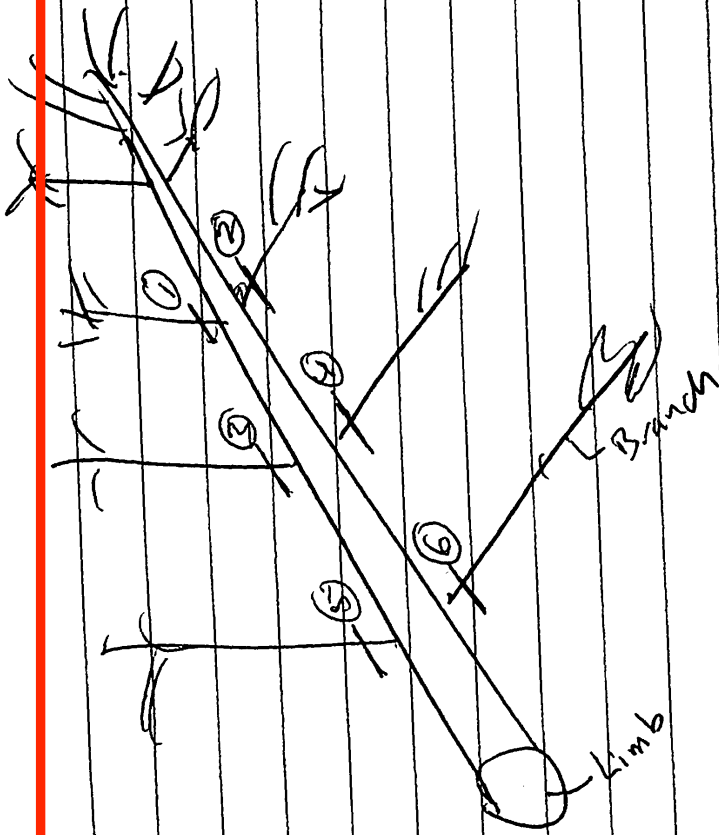

BASE

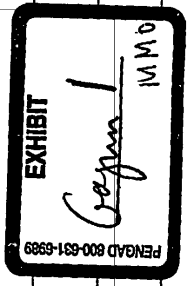
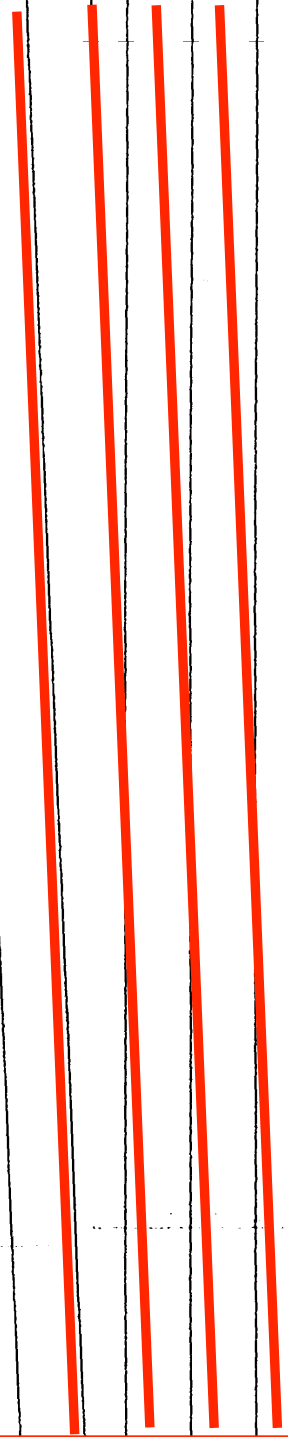

the Red box shows the Untrimmed ruled lines with nubs showing.  
I added 4 red lines to show the nubs are perfectly aligned with the existing lines on the other side and are aligned with the ruled lines that have the drawing